

LK 112 S 120,140,160,180,200 D 200

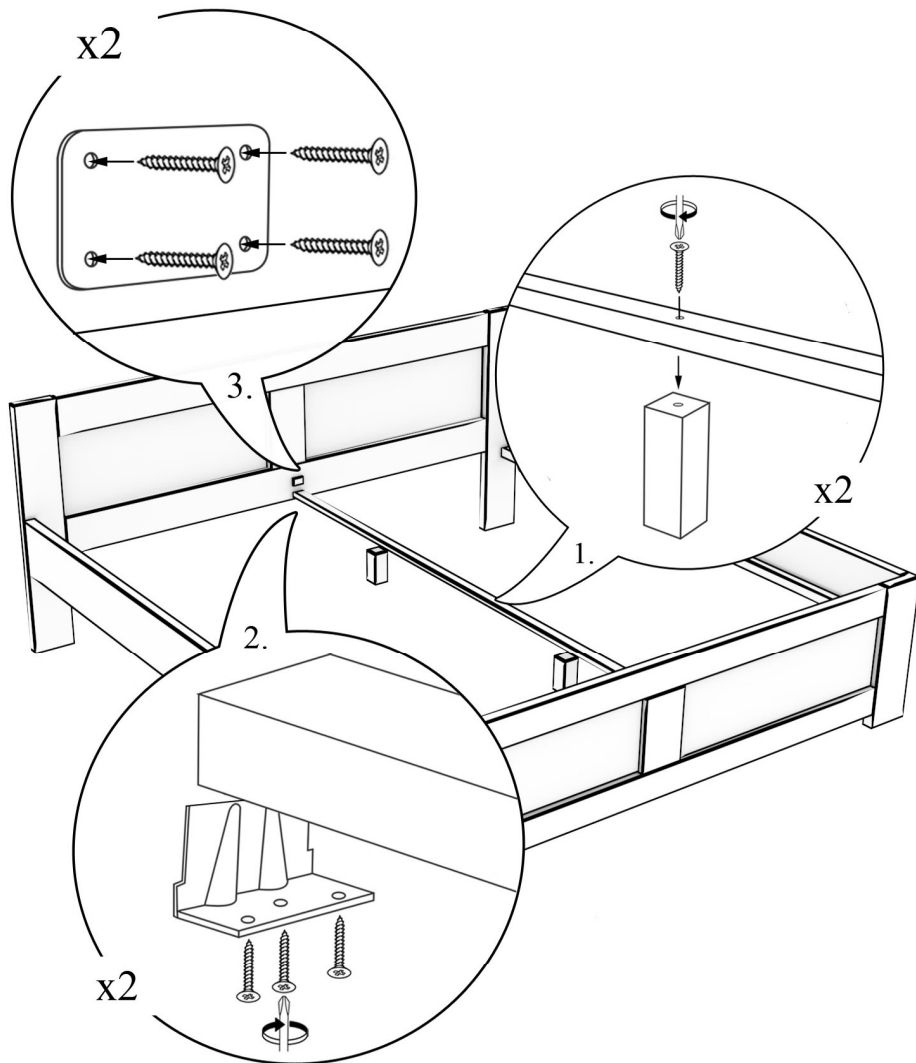

PL : Dla wzmocnienia konstrukcji zaleca się przykręcenie stelaża do ramy łóżka
 SK : Pre posiljenje konstrukcije, odporučame rám roštu priskrutkovat' na rám posteje
 EN : To strengthen the bed construction it is recommended to screw the slat under the mattress to frame of the bed
 CS : Prt posiljenje strukturu, doporučuje se šroub rámeček na rám posteje

